

Data Sheet



Article number: 021300705017

Description: Sealing Clamp S 17 W5

Measures

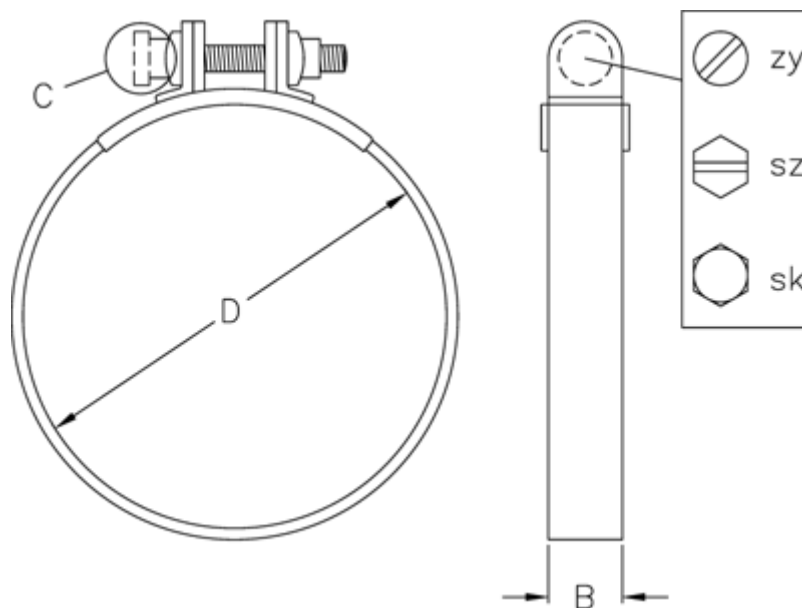

C (screw type) = SZ

Diameter D = 17

Width B = 12